

**PARTS LIST: TT5313**

1	Driver/Left side Running Board	12	10mm x 35mm Hex Bolts
1	Passenger/Right side Running Board	24	10mm x 27mm x 3mm Flat Washers
1	Driver/Left side Front Mounting Bracket	12	10mm Nylon Lock Nuts
1	Passenger/Right side Front Mounting Bracket	12	8mm x 30mm Hex Bolts
2	Driver/Left side Mounting Brackets	12	8mm x 24mm x 2mm Flat Washers
2	Passenger/Right side Mounting Brackets	12	8mm Lock Washers

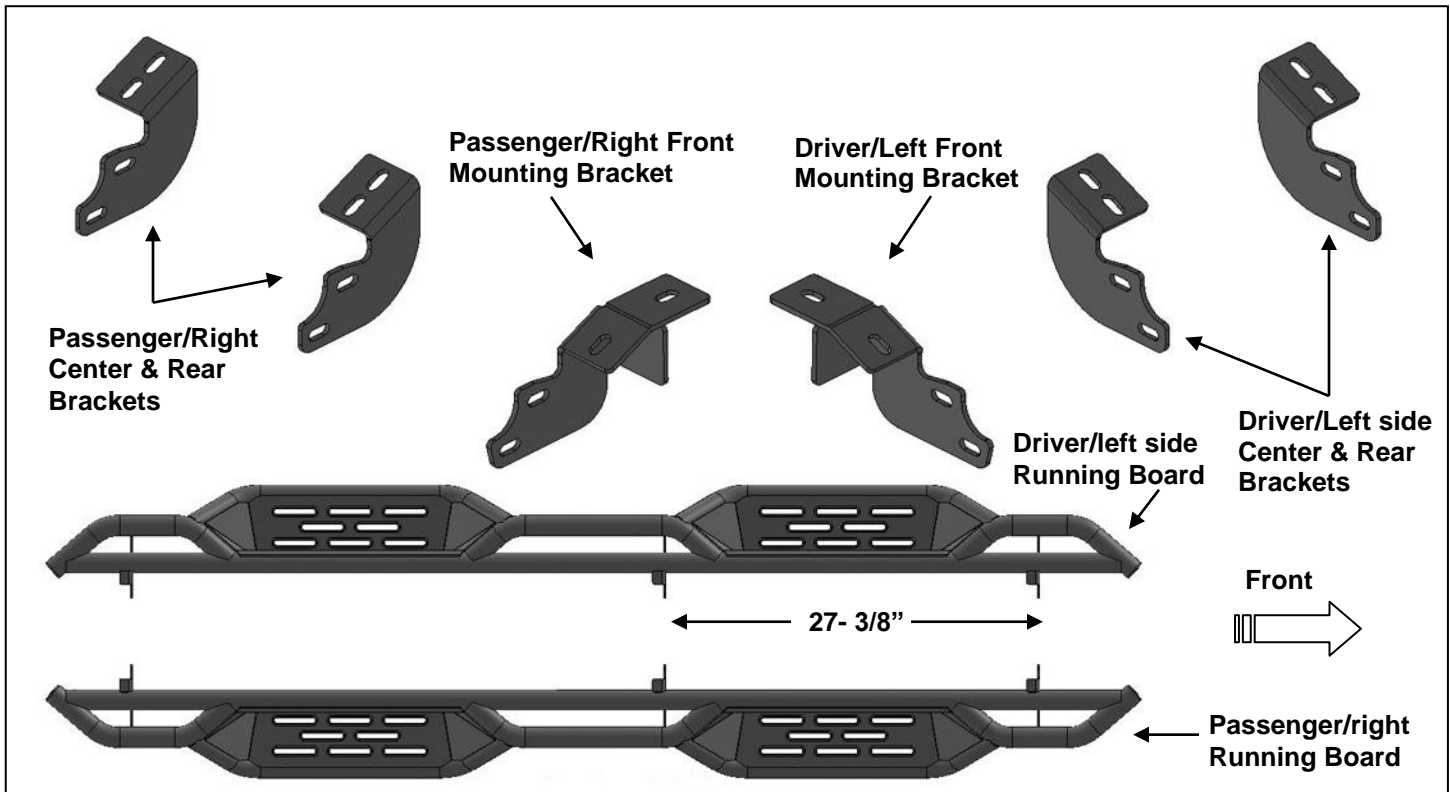

**PROCEDURE:**

1. REMOVE CONTENTS FROM BOX. VERIFY ALL PARTS ARE PRESENT. READ INSTRUCTIONS CAREFULLY. USE ILLUSTRATION TO PROPERLY IDENTIFY BRACKETS AND SIDEBARS.
2. Starting on the driver side front of the vehicle, remove the plastic plugs or bolts covering the threaded holes in the body panel, **(Figure 1)**.
3. Select the driver side front Mounting Bracket, **(Figure 2)**. Attach the Bracket to the body panel using the included (2) 8mm x 30mm Hex Bolts, (2) 8mm Lock Washers and (2) 8mm Flat Washers, **(Figures 2 & 3)**. Do not tighten hardware at this time.
4. Move along the cab to the center mounting location, **(Figure 4)**. Repeat **Steps 2 & 3** to install the driver side center/rear Mounting Bracket, **(Figure 5)**.
5. Continue along the body panel to the back of the cab and locate the rear mounting location, **(Figure 6)**. Repeat **Steps 2 & 3** to install the driver side center/rear Mounting Bracket, **(Figure 7)**.
6. Select the driver side Running Board. **NOTE:** Use the illustration above to determine the driver side Running Board. The distance between the front and center mounting tab is approximately 27-3/8" wide.
7. With assistance, attach the driver side Running Board to the rear facing side of the Mounting Brackets using (6) 10mm x 35mm Hex Bolts, (12) 10mm Flat Washers and (6) 10mm nylon Lock Nuts, **(Figures 8 & 9)**. Do not tighten hardware at this time.
8. Properly level and adjust the Running Board and fully tighten all hardware.
9. Repeat **Steps 2—8** for Passenger/Right side Running Board installation.
10. Do periodic inspections to the installation to make sure that all hardware is secure and tight.

To protect your investment, wax this product after installing. Regular waxing is recommended to add a protective layer over the finish. Do not use any type of polish or wax that may contain abrasives that could damage the finish. Mild soap may be used also to clean the Running Board.

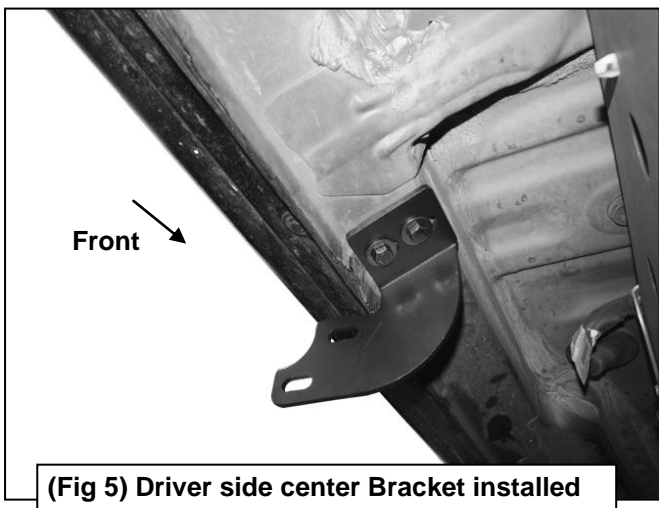
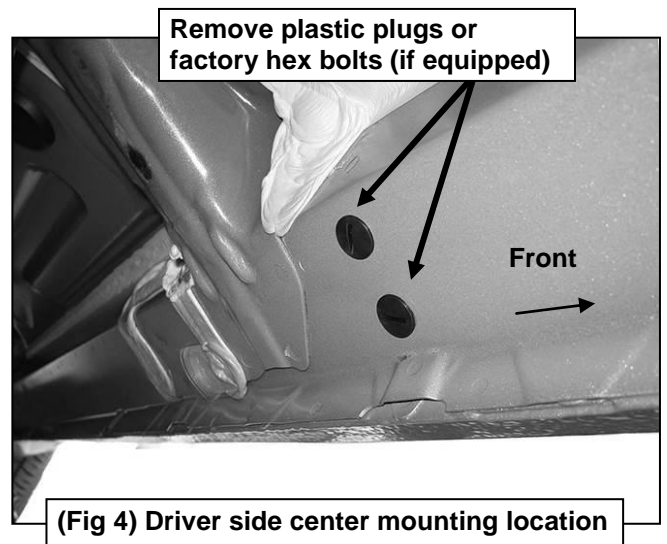
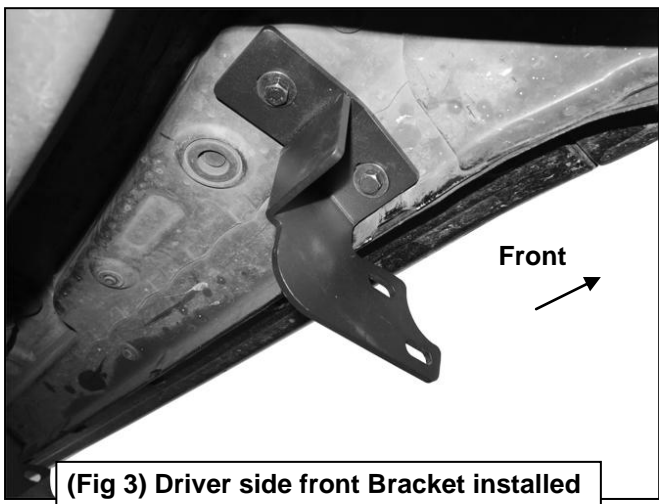
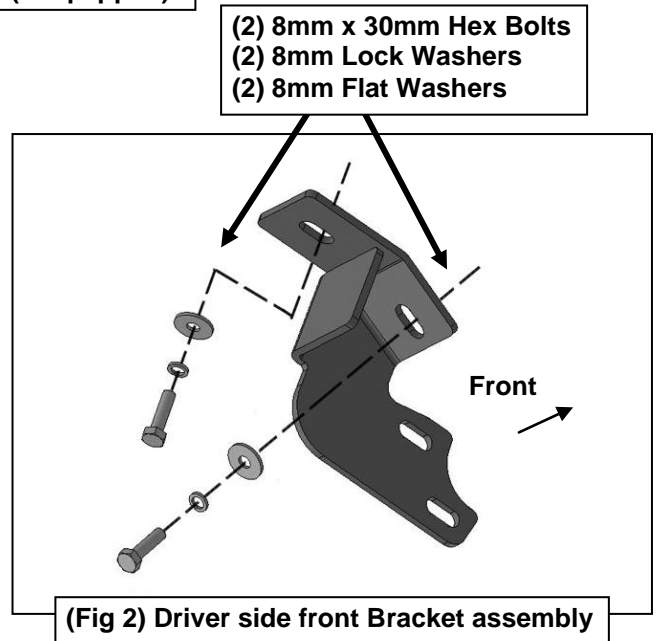
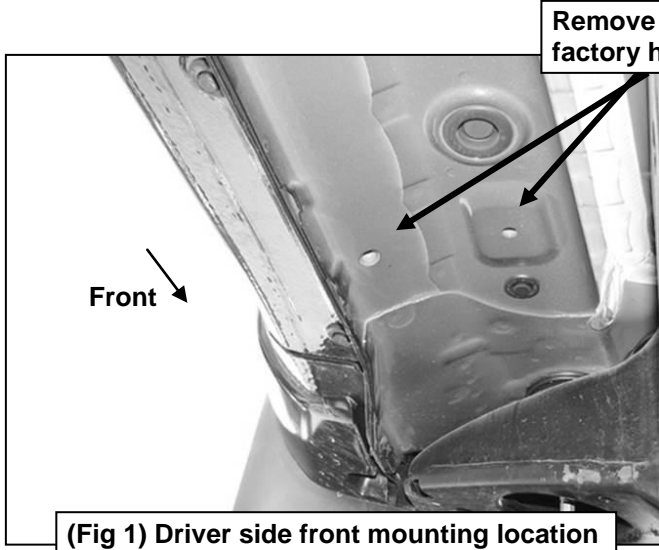

### Driver/Left Side Installation Pictured

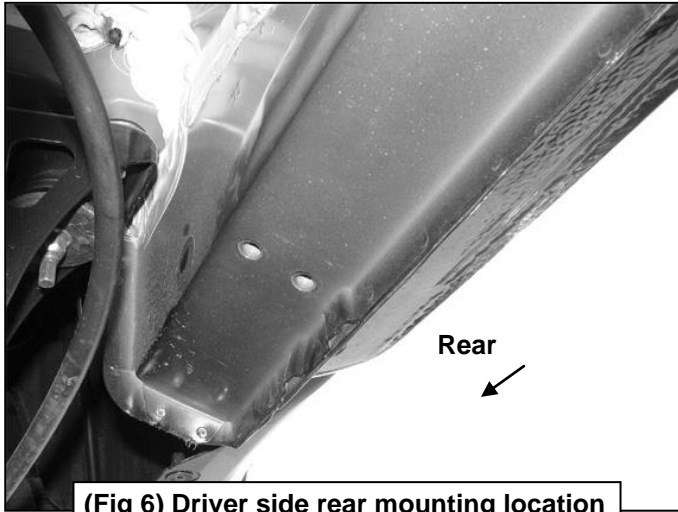

(Fig 6) Driver side rear mounting location

- (2) 8mm x 30mm Hex Bolts
- (2) 8mm Lock Washers
- (2) 8mm Flat Washers

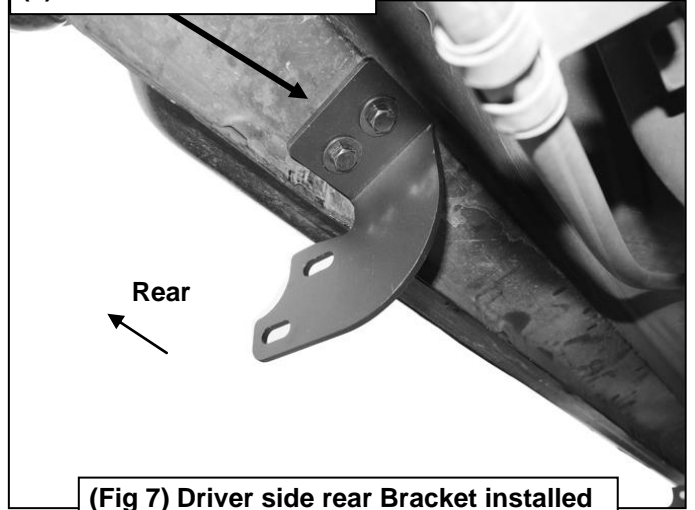

(Fig 7) Driver side rear Bracket installed

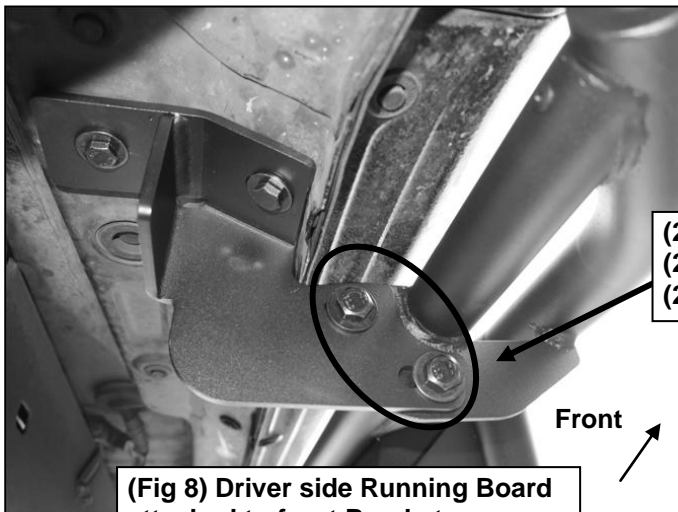

- (2) 10mm Hex Bolts
- (2) 10mm Flat Washers
- (2) 10mm Nylon Lock Nuts

(Fig 8) Driver side Running Board attached to front Bracket



(Fig 9) Driver side Running Board attached to rear Bracket



Complete Installation