

2007-2020 WRANGLER JK, JL INTERIOR CARGO RACK PART #5147

PARTS LIST:

1	Center Rack Tray	10	8-1.25mm x 25mm Button Head Bolts
1	Driver/left Side Panel	20	8mm x 24mm x 2mm Flat Washers
1	Passenger/right Side Panel	10	8mm Nylon Lock Nuts
1	Driver/left Side Panel Base Seal	1	5mm Wrench
1	Passenger/right Side Panel Base Seal		

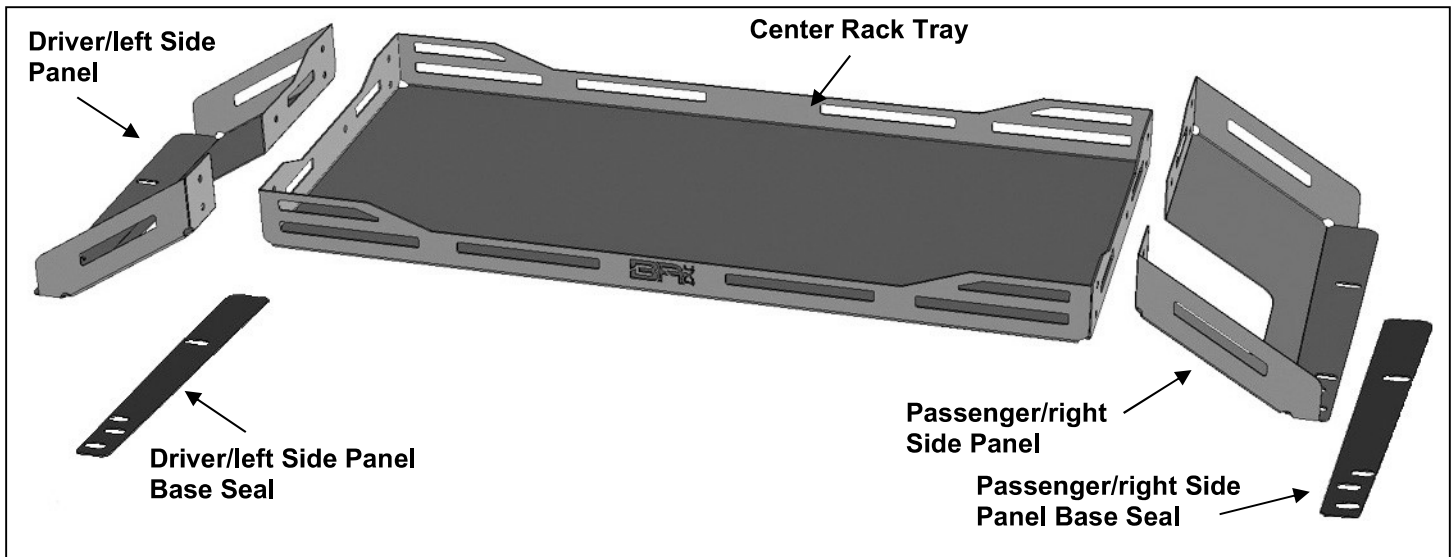

PROCEDURE:

REMOVE CONTENTS FROM BOX. VERIFY ALL PARTS ARE PRESENT. READ INSTRUCTIONS CAREFULLY BEFORE STARTING INSTALLATION. ASSISTANCE IS HIGHLY RECOMMENDED.

1. Move to the driver/left rear side of the vehicle. Remove the (2) factory bolts attaching the side of the top to the vehicle, **(Figure 1)**.
2. Select the driver/left Side Panel. Apply the driver/left Adhesive Backed Base Seal to the bottom of the Side Panel, **(Figure 2)**.
3. Reuse the factory bolts to attach the driver/left Side Panel to the inside of the top, **(Figure 3)**. Do not fully tighten hardware at this time.
4. Select the passenger/right Side Panel. Repeats **Step 1—3** to install the passenger/right Side Panel, **(Figure 7)**.
5. Select the Center Tray. Slide the Tray into position between the Side Panels. Attach the Tray to the Side Panels with the included (10) 8mm x 25mm Button Head Bolts, (20) 8mm Flat Washers and (10) 8mm Nylon Lock Nuts, **(Figures 4—7)**. **NOTE:** Tighten the Tray to Side Panel bolts first, then tighten the factory hardware attaching the Side Panels to inside of top.
6. Do periodic inspections to the installation to make sure that all hardware is secure and tight.

To protect your investment, Do not use any type of polish or wax that may contain abrasives that could damage the finish. Mild soap may be used to clean the Inside Cargo Rack.

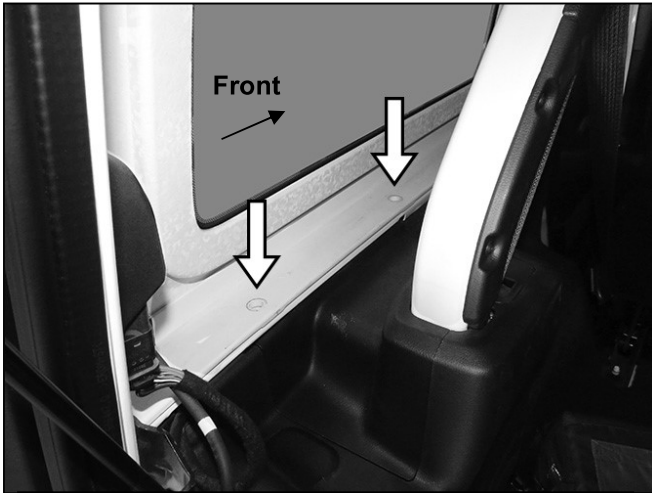

(Fig 1) Remove (2) factory bolts attaching side of top to body (driver/left side pictured)

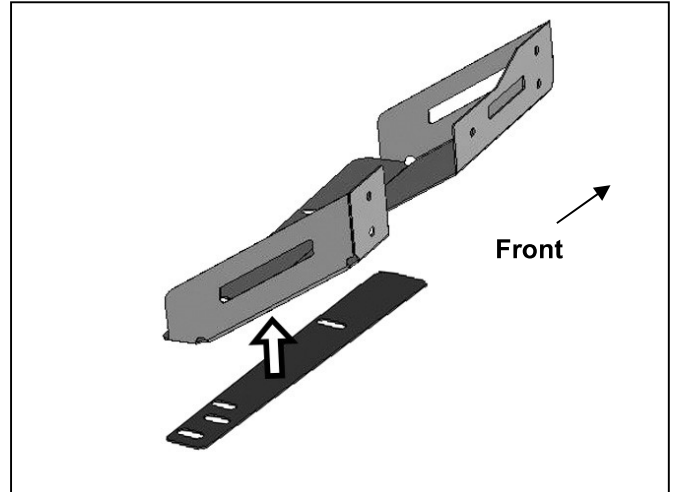

(Fig 2) Attach adhesive backed Seal to bottom of driver/left Side Panel



(Fig 3) Reuse (2) factory bolts to attach driver/left Side Panel to inside of top. Repeat to install the remaining passenger/right Side Panel

- (5) 8mm x 25mm Button Head Bolts
- (10) 8mm Flat Washers
- (5) 8mm Nylon Lock Nuts

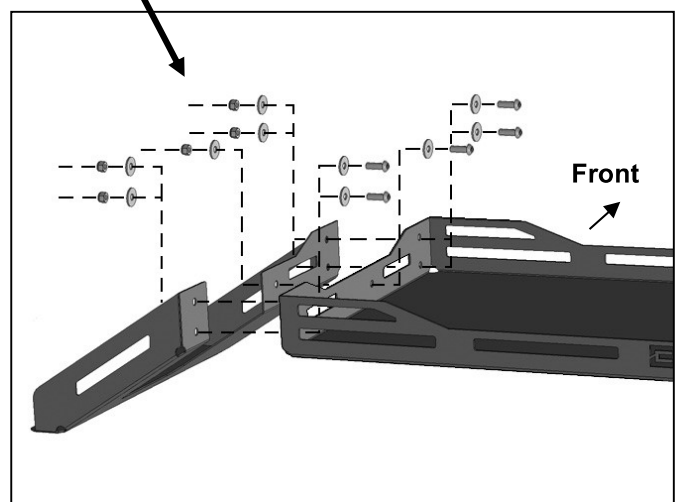

(Fig 4) Attach Center Tray to driver/left Side Panel

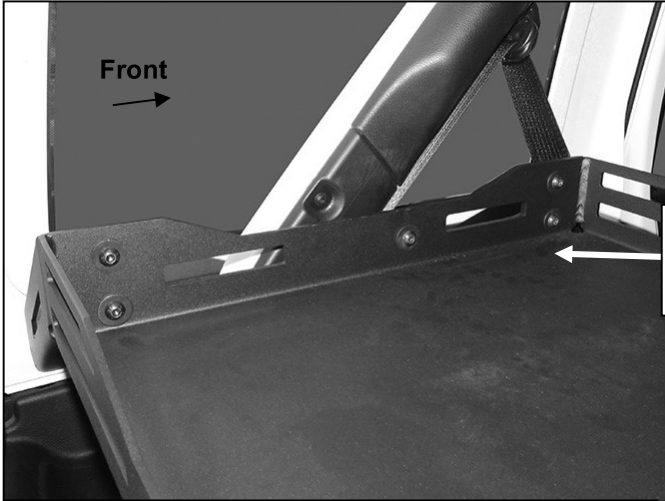

(5) 8mm x 25mm Button Head Bolts
(10) 8mm Flat Washers
(5) 8mm Nylon Lock Nuts

(Fig 5) Attach Center Tray to driver/left Side Panel

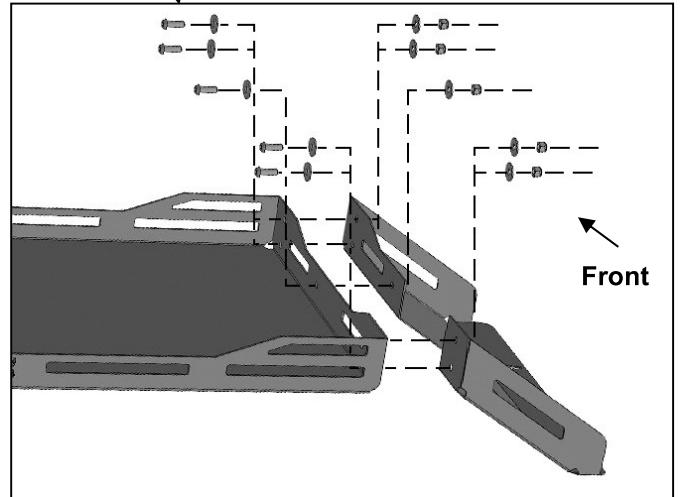

(Fig 6) Attach Tray to passenger/right Side Panel

(5) 8mm x 25mm Button Head Bolts
(10) 8mm Flat Washers
(5) 8mm Nylon Lock Nuts

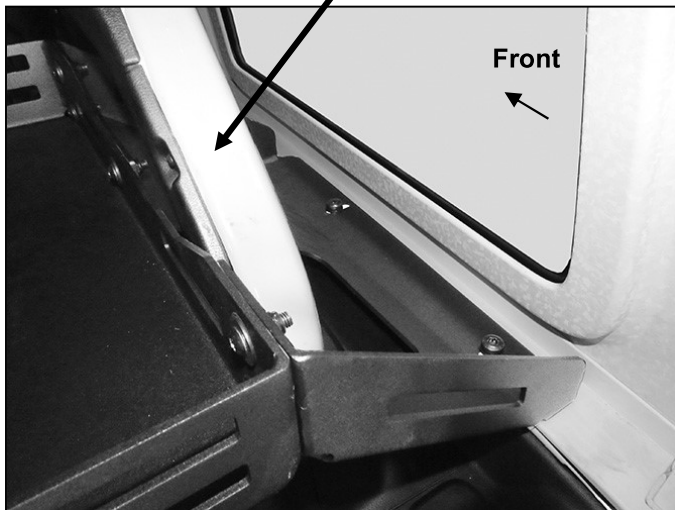

(Fig 7) Passenger/right side of Rack installed