



OMIX-ADA, Inc.

460 HORIZON DR. SUITE 100 | SUWANEE, GA 30024 | PHONE: 770-614-6101 | FAX: 770-614-6069 | info@omix-ada.com

Part #11226.0
11226.0
11226.0
11226.0

Elite Tail Light Guard PATENT PENDING

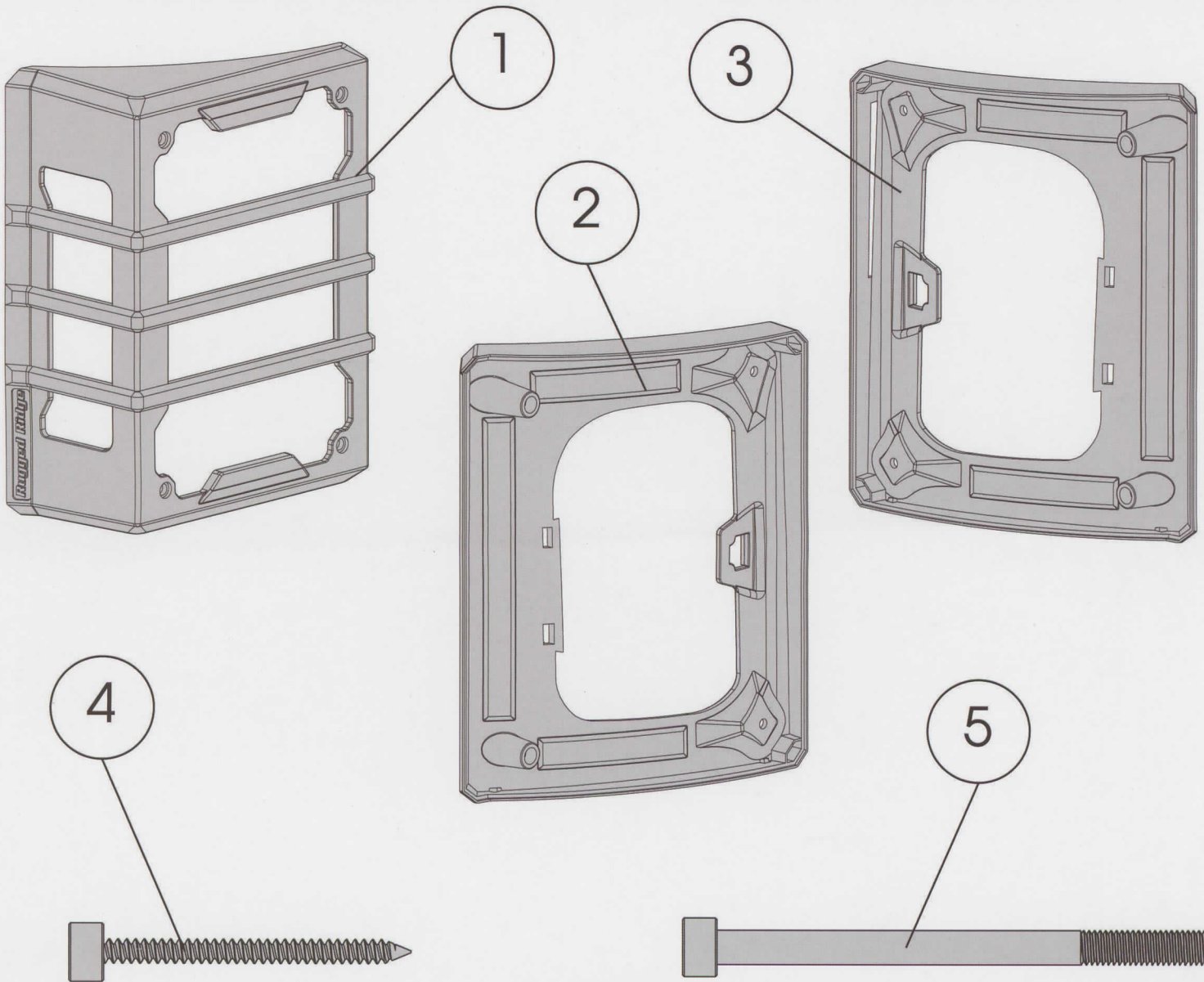

Components

- | | |
|----------------|-----|
| 1. Guard | (2) |
| 2. Housing, LH | (1) |
| 3. Housing, RH | (1) |
| 4. #6 Screw | (4) |
| 5. M5 Screw | (4) |

OMIX-ADA® TECHNICAL SUPPORT

PHONE: M-F 8am - 5pm EST 1-800-449-6649 | EMAIL: techsupport@omix-ada.com

FOR WARRANTY INFORMATION VISIT: www.Omix-Ada.com



OMIX-ADA, Inc.

460 HORIZON DR. SUITE 100 | SUWANEE, GA 30024 | PHONE: 770-614-6101 | FAX: 770-614-6069 | info@omix-ada.com

Elite Tail Light Guard PATENT PENDING

1. Remove hardware from tail lights and disconnect from vehicle wiring harness.
2. Remove rear trim piece from both tail lights.

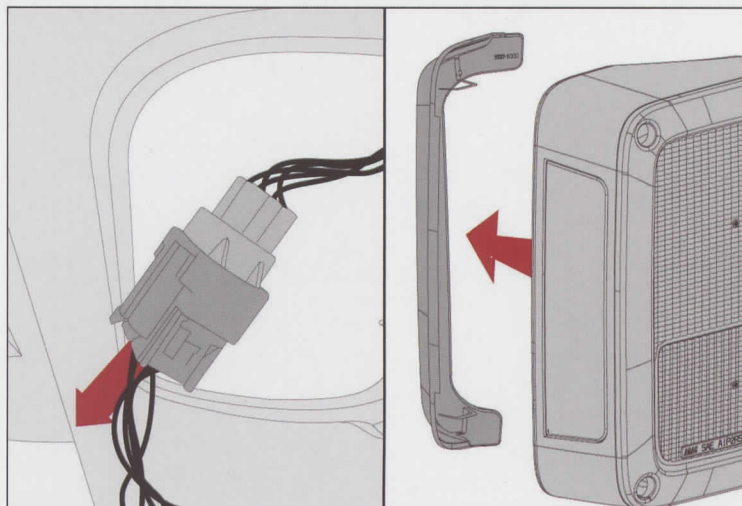

3. Encase tail light inside Housing and Guard using M5 Screws.

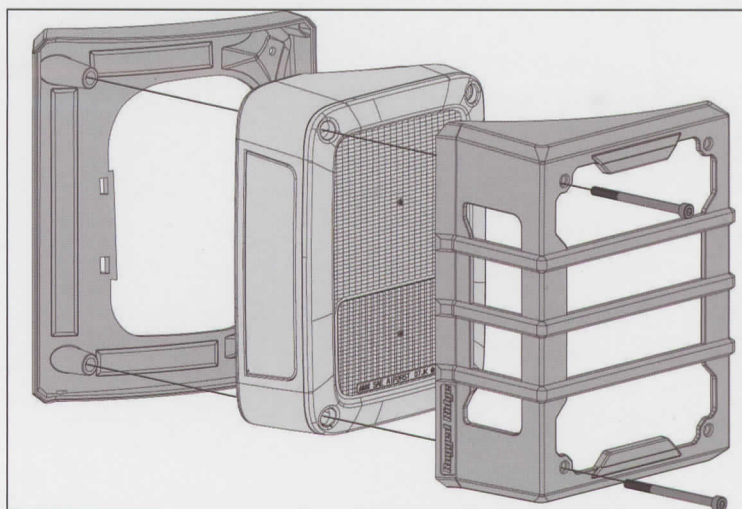

4. Reconnect tail light to vehicle wiring harness.
5. Secure assembly to vehicle using #6 Screws in remaining attachment points.

