



OMIX-ADA, Inc.

460 HORIZON DR. SUITE 400 | SUWANEE, GA 30024 | PHONE: 770-614-6101 | FAX: 770-614-6069 | info@omix-ada.com

LED Rock Light Kit

1. Place LED Rock Light on rear fender liner in front of the wheel, mark mounting location, and remove fender liner.

NOTE: These are suggested mounting points only.

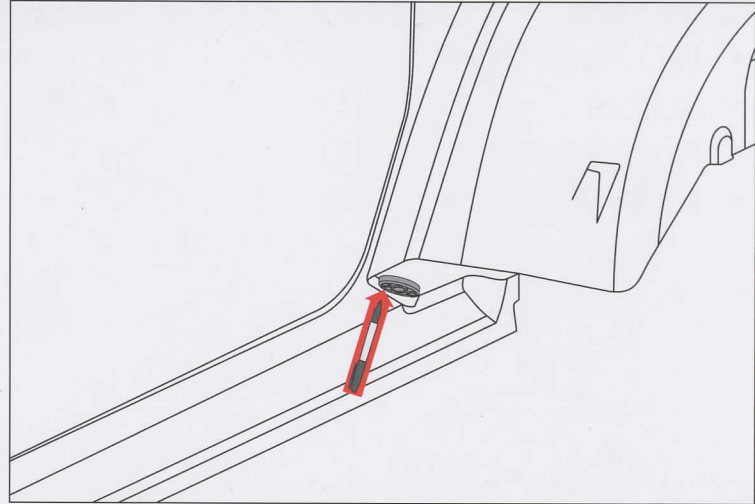

2. Place LED Rock Light on front fender liner above the wheel, mark mounting location and remove fender liner.

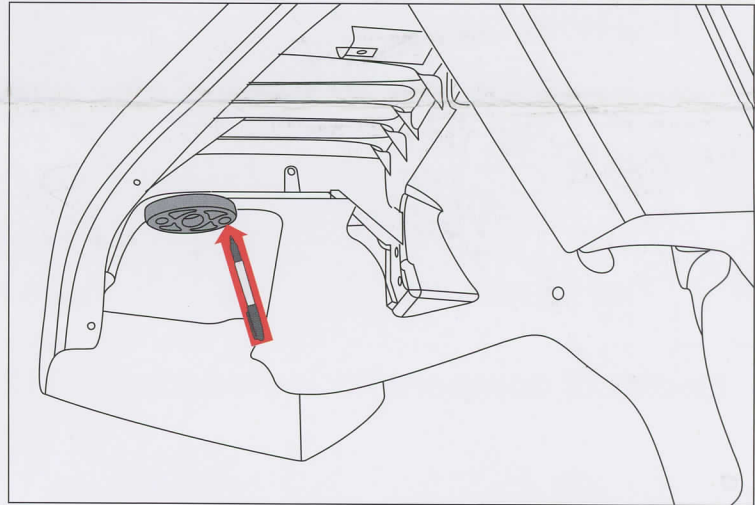

3. Drill mounting holes in each fender liner with a 1/4" drill bit.

NOTICE

Use caution when drilling holes to ensure best possible fit of product.

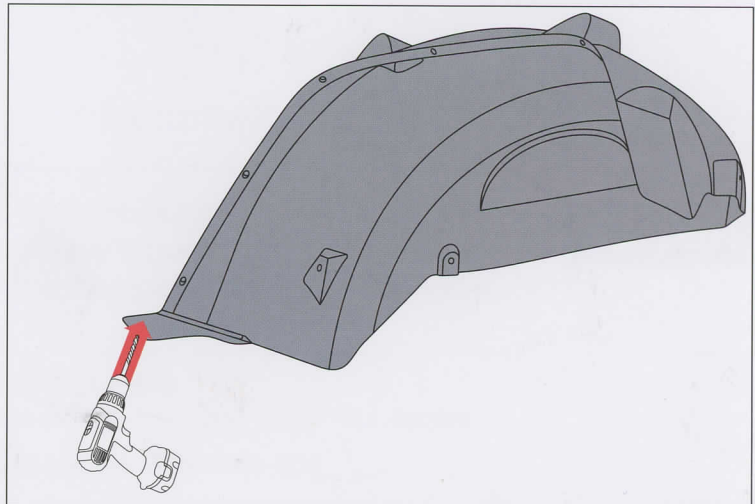



OMIX-ADA, Inc.

Part # 11232.3
11232.4

460 HORIZON DR. SUITE 400 | SUWANEE, GA 30024 | PHONE: 770-614-6101 | FAX: 770-614-6069 | info@omix-ada.com

LED Rock Light Kit

CONTENTS:

- LED Rock Light (4)
- Splitter (1)
- Flat Mount (4)
- Tube Mount (4)

HARDWARE:

- Screw (8)
- Nut (8)

TOOLS REQUIRED:

- Drill
- 1/4" Drill Bit
- 6 mm Allen Key
- 10 mm Wrench



LED Rock Light x 4

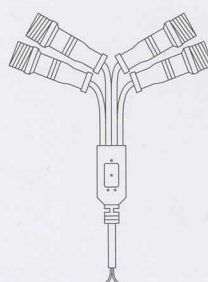

Splitter x 1



Nut x 8

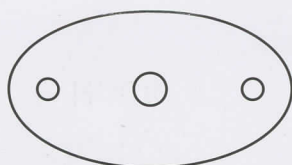

Flat Mount x 4

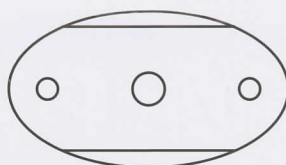

Tube Mount x 4



Screw x 8

Electrical components included with 11232.40 only

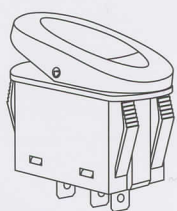

Rocker Switch x 1

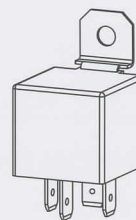

Wiring Kit x 1

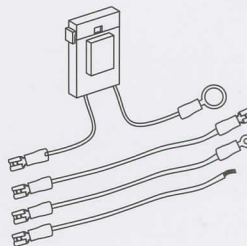

NOTICE

Careful attention is required to this instruction or operation, but does not generally relate to personal injury. Damage to your product or other property may result if you do not follow instructions.

OMIX-ADA® TECHNICAL SUPPORT

PHONE: M-F 8am - 5pm EST 1-800-449-6649 | EMAIL: techsupport@omix-ada.com

FOR WARRANTY INFORMATION VISIT: www.Omix-Ada.com



OMIX-ADA, Inc.

460 HORIZON DR. SUITE 400 | SUWANEE, GA 30024 | PHONE: 770-614-6101 | FAX: 770-614-6069 | info@omix-ada.com

LED Rock Light Kit

4. Install LED Rock Lights on fender liners using the Flat Mount rubber spacers, screws, nuts, 10mm wrench, and 6mm Allen Key. Once finished, reinstall fender liners.



5. Run wiring for rear LED Rock Lights along the pinch seam, securing with zip ties where necessary, and up through the fender into the engine bay.

TIP: To help guide wiring through fender, drop a piece of string down the fender, tie to wiring, and pull up.

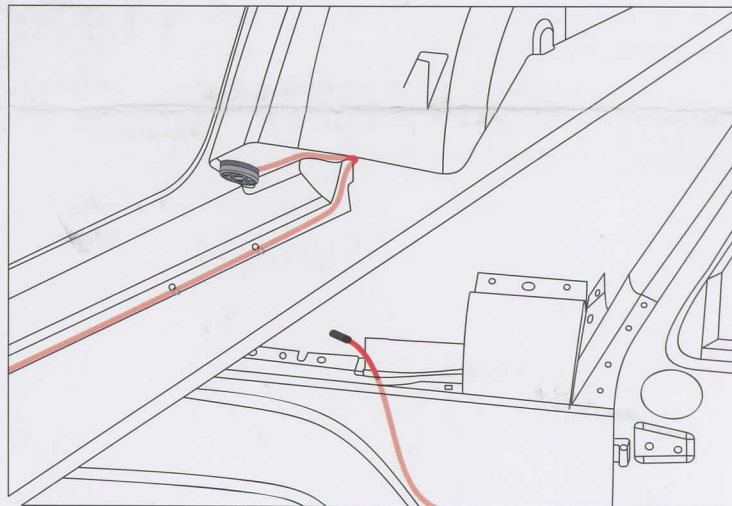

6. Run wiring for front LED Rock Lights along the fender liner and up through the fender into the engine bay.

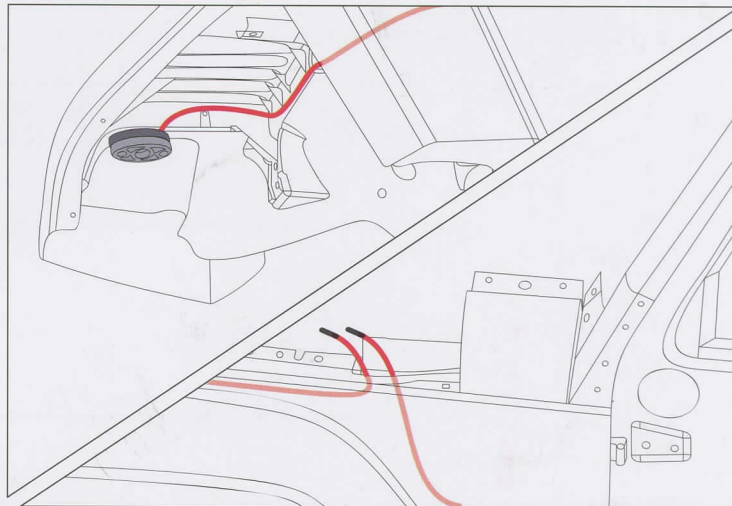



OMIX-ADA, Inc.

460 HORIZON DR. SUITE 400 | SUWANEE, GA 30024 | PHONE: 770-614-6101 | FAX: 770-614-6069 | info@omix-ada.com

LED Rock Light Kit

7. Connect the LED Rock Lights to the Splitter.

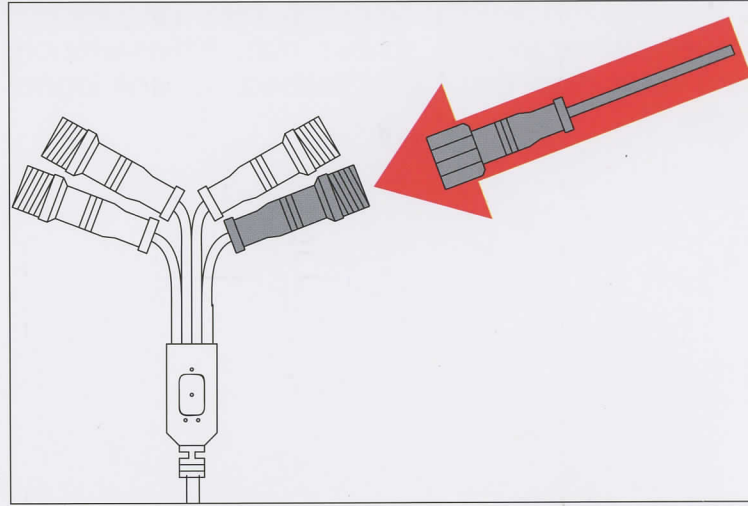

8. Wire the Splitter to a relay and switch combination using the provided wiring diagram. Connect the red wire (positive) on the Splitter to the +12V OUT terminal on the relay, and the black wire (negative) to ground.

NOTICE

For part 11232.40, cut the black wire bridging terminal 86 and 87 on the relay and ground to chassis. Use provided wiring diagram for reference.

