

Installation Instructions

Description: BUMPER FOR JEEP WRANGLER JK 12

No.	Description	Qty	Size	No.	Description	Qty	Size
1	Winger	2		6	Hex nut	6	M10
2	Top tube	1		7	Hex bolt	2	M10x35
3	Bumper	1		8	Washer	12	D10
4	Washer	8	D10	9	Lock washer	12	D10
5	Lock washer	8	D10	10	Hex bolt	12	M10x30

Installation Steps:

1. Reference parts lists and installation drawings, check the accessories are complete.
2. Remove the factory bumper & the frame bracket, to fix the bumper to the frame with the screws. (Fig.1 & Fig.2 & Fig.3AB)
3. All bolts are screwed on and adjust the best position to slowly tighten all bolts.
4. Check for leakage on the bolts, make sure tighten all the bolts.

Installation Diagram:

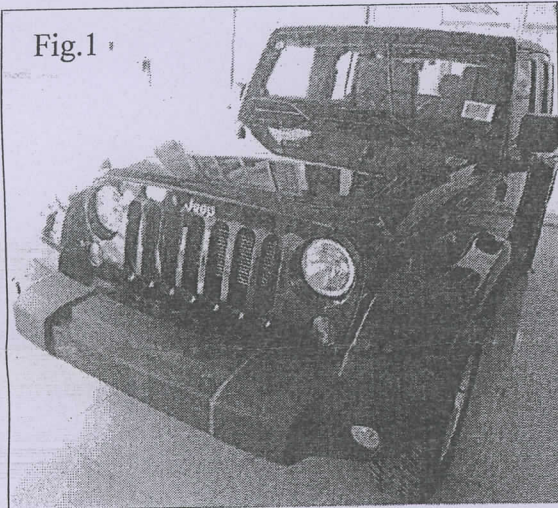

Fig.1

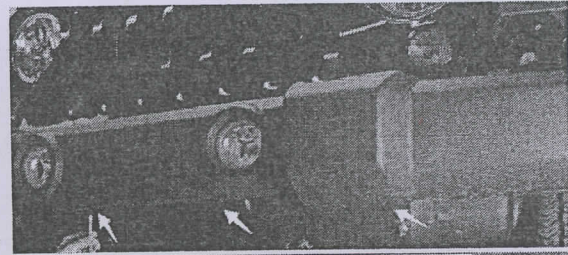
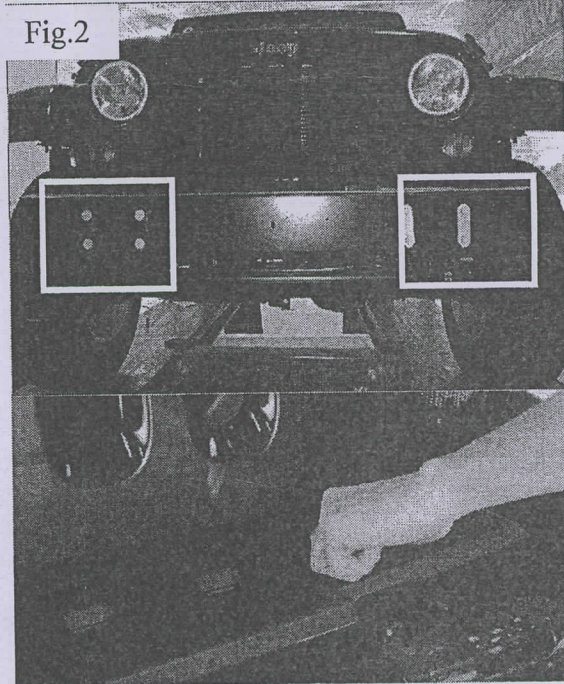

Fig.2



Remove the plastic bumper & the frame bracket (Fig.1 & Fig.2 & Fig.3AB)

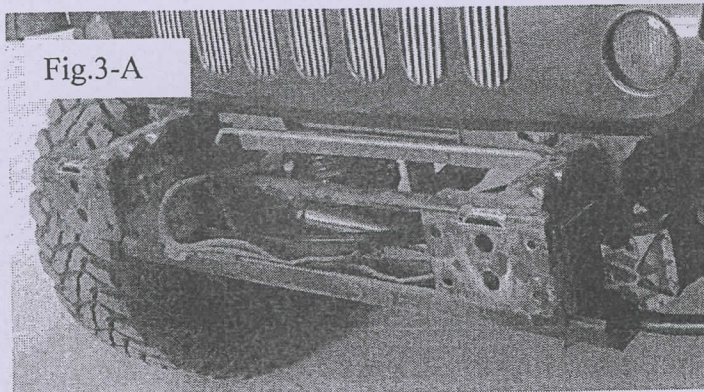

Fig.3-A

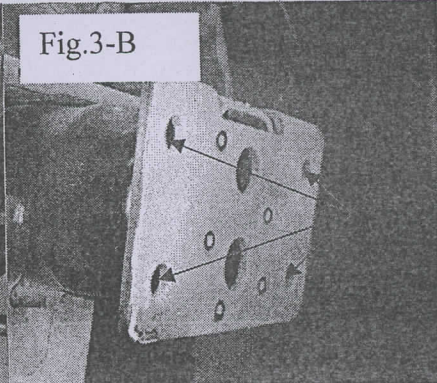

Fig.3-B

Place the bumper onto vehicle and install 12mm washers and locknuts. (Fig.4-AB)

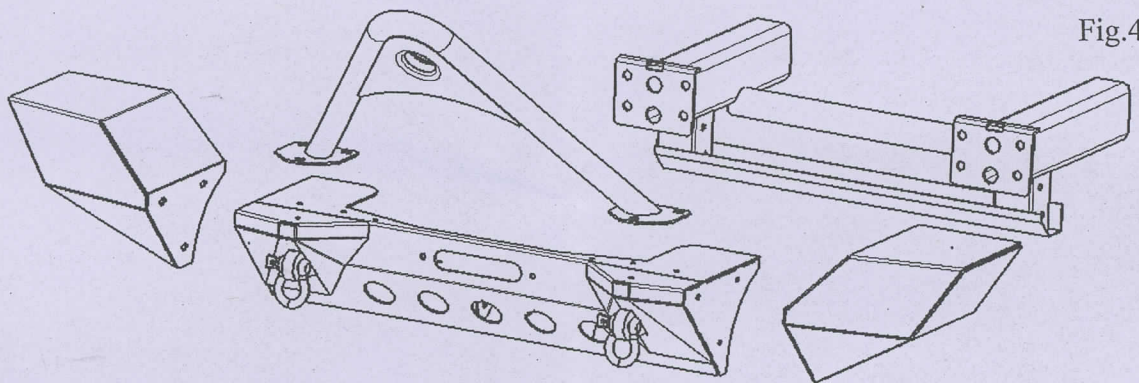

Fig.4-A

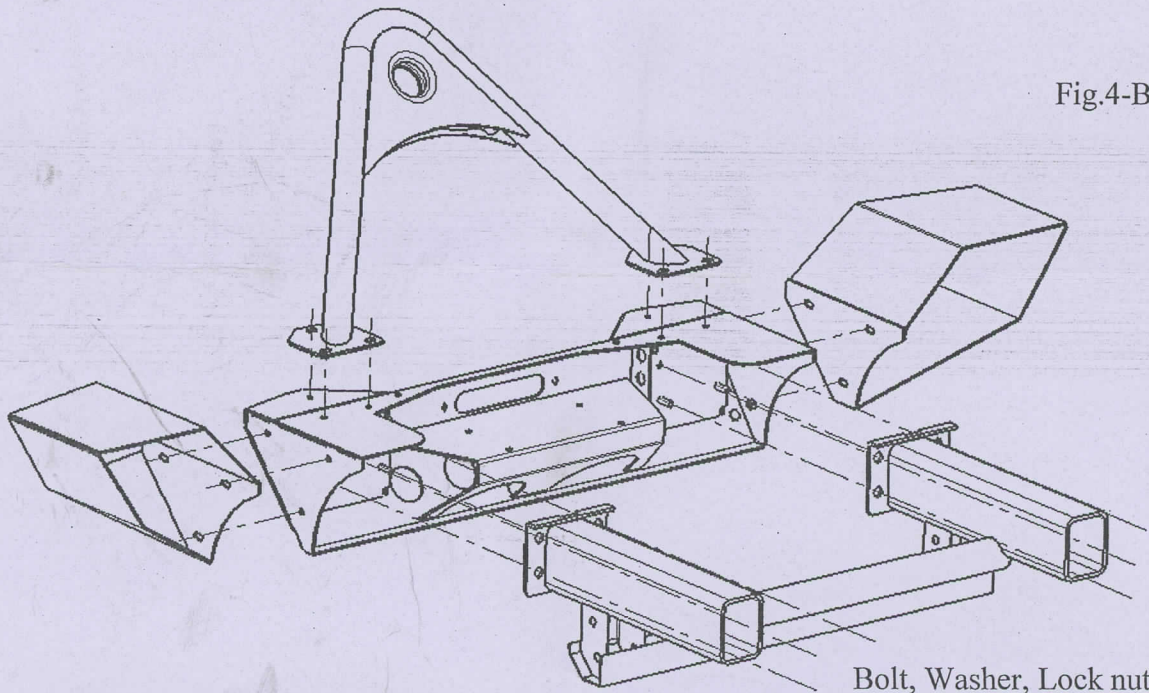

Fig.4-B

Bolt, Washer, Lock nut, Nut.